



KB article reference no. Q101104

Version: 1.1

Keywords: KlasHopper 600 PCMCIA, KIV-7

Answer with a KlasHopper 600 connected to a KIV-7

The information in this article applies to:

- Windows 2000 Professional
- KlasHopper 600 PCMCIA
- Dial-up Networking
- KIV-7

Table of Contents

1.0 Introduction.....	2
2.0 Cable Connections	2
3.0 Configure the KIV-7	2
4.0 KlasHopper 600 PCMCIA Setup (Answer):.....	3
5.0 Dial-up Connection Configuration	4

Table of Figures

Figure 1. Sample Scenario using the KlasHopper 600 PCMCIA	2
Figure 2. KlasHopper 600 PCMCIA Setup Screen	3
Figure 3. Opening the Network and Dial-up Connections Window.....	4
Figure 4. Starting the Network Connection Wizard	4
Figure 5. Choosing the Network Connection Type	5
Figure 6. Selecting the Network Device	5
Figure 7. Configuring the Incoming Virtual Private Connection	6
Figure 8. Selecting the Allowed Users	6
Figure 9. Accepting the Default Networking Components	7
Figure 10. Completing the Network Connection Wizard	7

1.0 Introduction

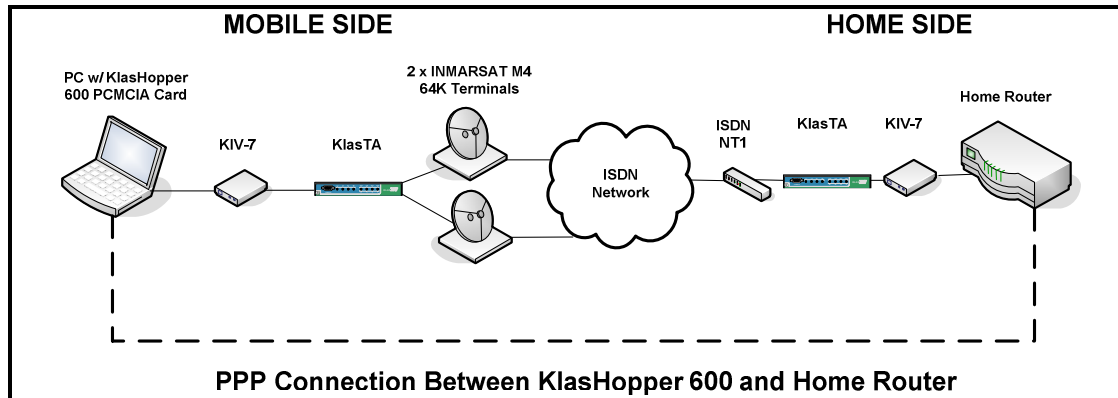

Figure 1. Sample Scenario using the KlasHopper 600 PCMCIA

This document describes how to configure the KlasHopper 600 PCMCIA to answer with a KIV-7. Figure 1 represents a typical KlasHopper scenario in a deployed environment using satellite communications to connect back to a home network. In this example, the KlasHopper 600 on the Mobile Side is terminating a PPP connection using the KIV-7 for Type-1 Encryption. On the Home Side, the PPP connection can be initiated by either a router or another PC. On both sides, a KlasTA is used to access the Public ISDN network through the M4 INMARSAT terminals. Follow the directions in this document to configure the KlasHopper 600 network interface and complete the steps required to create and use a Dial-up Networking connection from a Windows 2000 PC.

2.0 Cable Connections

Prior to beginning, ensure the following cable connections have been properly secured:

1. KlasHopper 600 cable (KHHS026) is connected to the female RS-530 connector on the KIV-7.
2. Black KIV-7 cable is connected to the male RS-530 connector of the KIV-7 and the female RS-530 synchronous serial port on the KlasTA.
3. ISDN cables are connected to the RJ-45 ISDN Output Ports 1 and 2 from KlasTA and the ISDN ports on each M4 Terminal.

3.0 Configure the KIV-7

The KIV-7 has a specific sequence of settings that allow it to encrypt data using the RS-530 serial data port. Follow the instructions from Application Note Q100008 in order to configure the KIV-7 so that it will work properly with the KlasHopper 600 and KlasTA.

4.0 KlasHopper 600 PCMCIA Setup (Answer):

To configure the KlasHopper 600 PCMCIA network interface, follow the instructions below.

1. From the Windows 2000 Desktop, go to Start – Programs – KlasHopper 600 PCMCIA – KlasHopper 600 PCMCIA Configure.
2. In the KlasHopper 600 PCMCIA Setup Screen, select the 'Hot Dial / Hot Answer' option from the 'Connection Mode' field.
3. Select 'RS-530/RS-449/X.21' option from the 'Interface' field.
4. Ensure the 'Raise DTR while listening for a call' option is selected.
5. No other settings are required. Click the 'OK' button to continue.

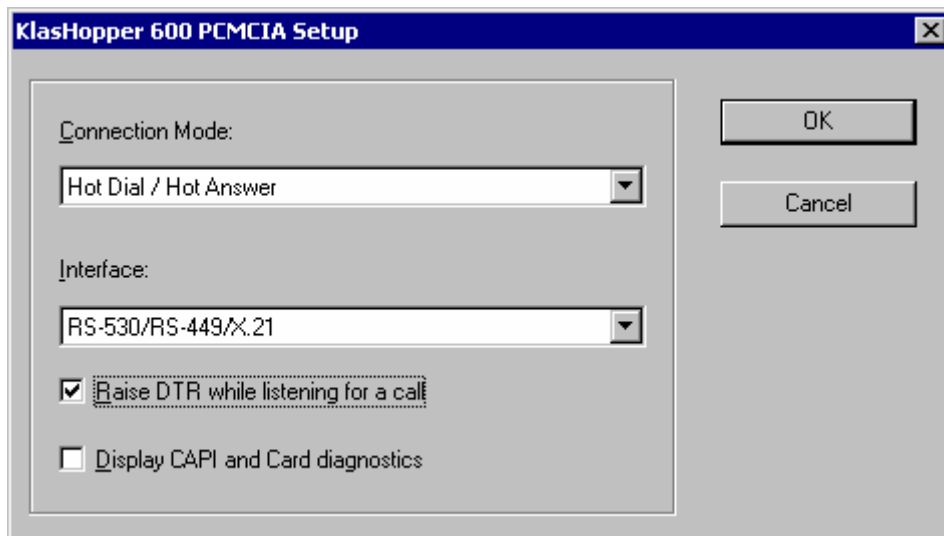

Figure 2. KlasHopper 600 PCMCIA Setup Screen

5.0 Dial-up Connection Configuration

To create a Dial-up Networking connection, follow the directions below.

1. Go to Start – Settings – Network and Dial-up Connections, as shown in Figure 3 below.

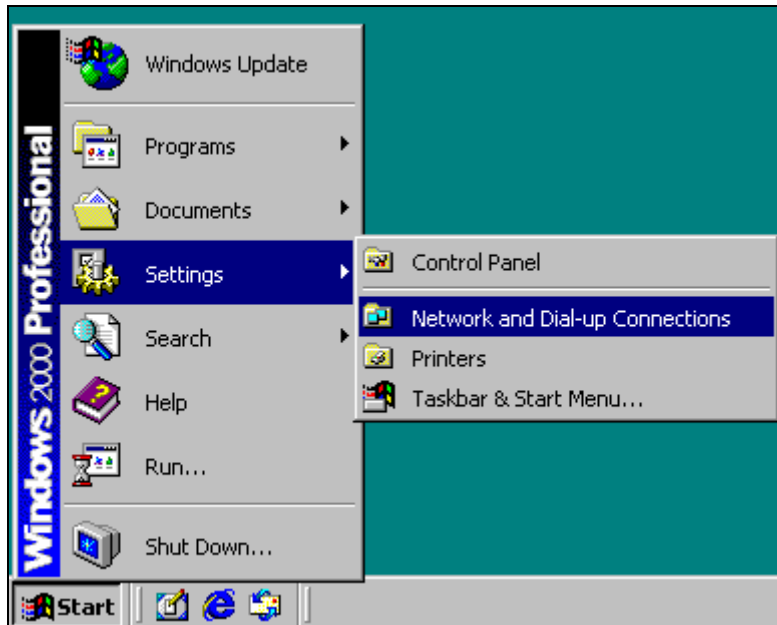

Figure 3. Opening the Network and Dial-up Connections Window

2. Double-click on the 'Make New Connection' icon to start the Network Connection Wizard. Click 'Next' to continue past the Welcome screen.



Figure 4. Starting the Network Connection Wizard

Answer with a KlasHopper 600 Connected to a KIV-7

3. Select the 'Accept incoming connections' option. Click 'Next' to continue.

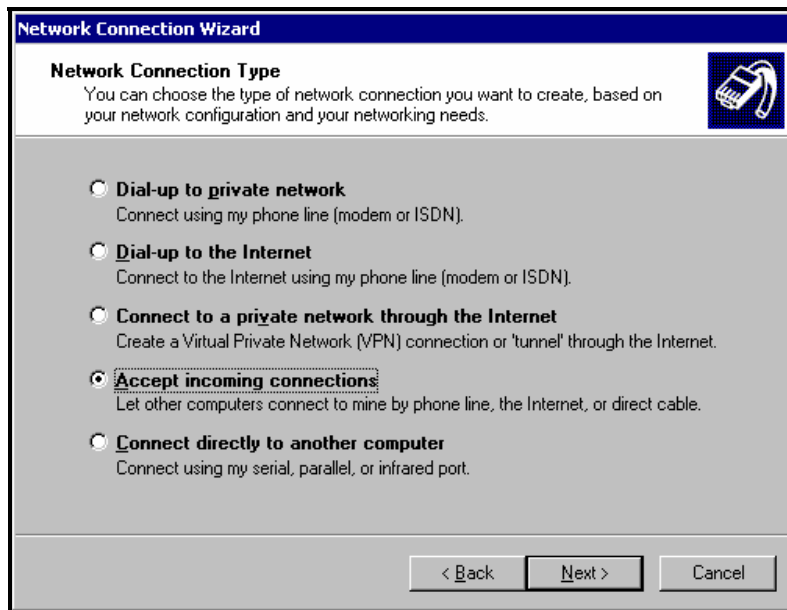

Figure 5. Choosing the Network Connection Type

4. Ensure that 'Modem – KlasHopper 600 PCMCIA PPP' is the only device that is selected. Click 'Next' to continue.

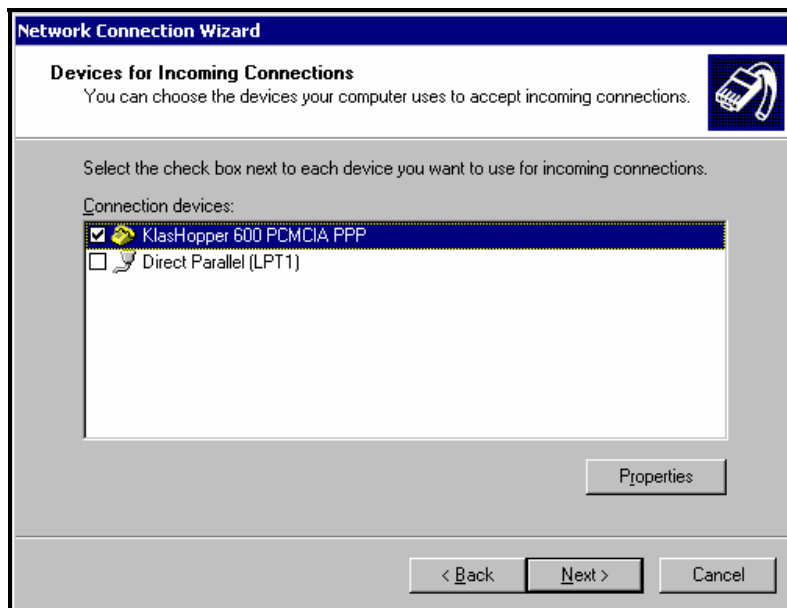

Figure 6. Selecting the Network Device

Answer with a KlasHopper 600 Connected to a KIV-7

5. Select the 'Do not allow virtual private connections' option. Click 'Next' to continue.

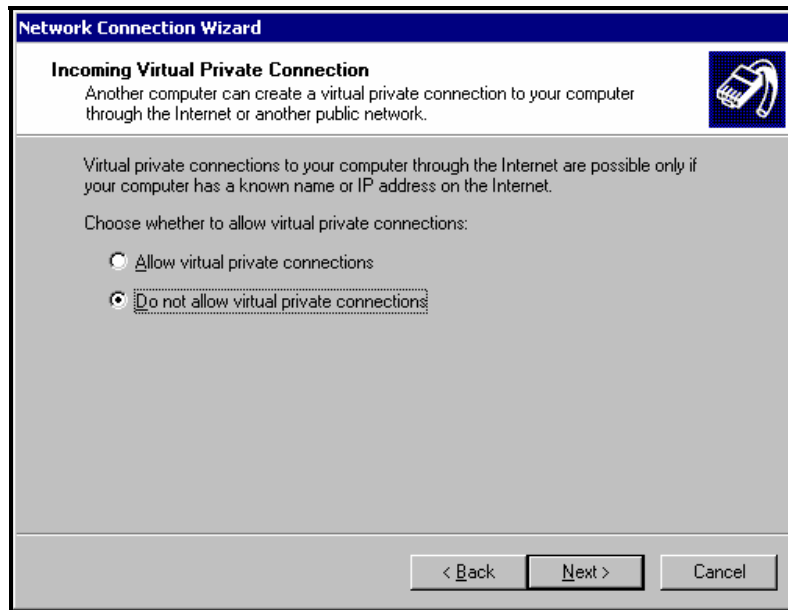

Figure 7. Configuring the Incoming Virtual Private Connection

6. Select which users are allowed to connect to your PC (Add users if required). Click 'Next' to continue.



Figure 8. Selecting the Allowed Users

7. Accept the default Networking Components selected. Click 'Next' to continue.

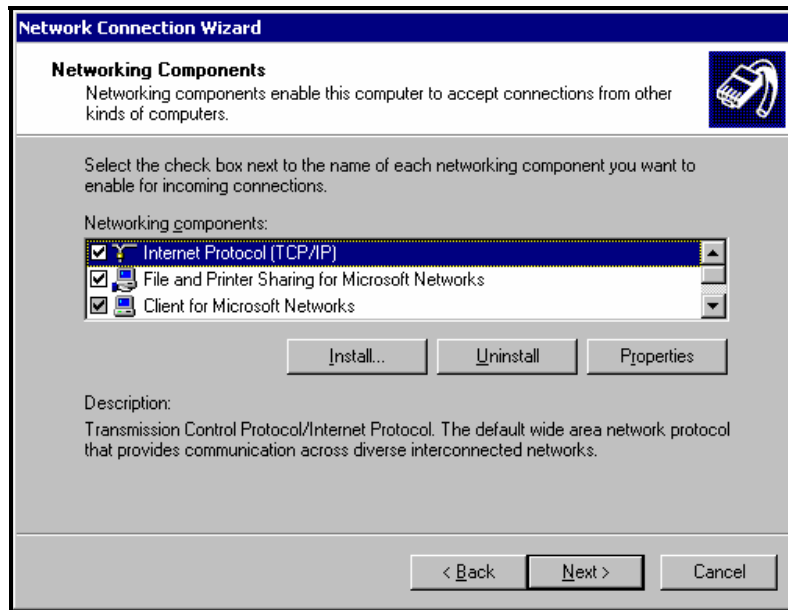

Figure 9. Accepting the Default Networking Components

8. The connection name cannot be changed. Click 'Finish' to complete the wizard.



Figure 10. Completing the Network Connection Wizard

The KlasHopper 600 PCMCIA is now configured to listen for and accept incoming calls.

MORE INFORMATION

For more information about the KlasHopper 600 PCMCIA and other Klas products, visit the following Klas website:

<www.klasonline.com>

Copyright © 2006 Klas Ltd. All rights reserved. All company and brand names are trademarks or registered trademarks of their respective owners.

DISCLAIMER OF WARRANTY: THE DOCUMENT IS PROVIDED AS IS, WITHOUT WARRANTY OF ANY KIND. TO THE MAXIMUM EXTENT PERMITTED BY APPLICABLE LAW, WITH RESPECT TO THE DOCUMENT AND / OR ANY ASSOCIATED ON-LINE INFORMATION, KLAS DISCLAIMS ALL WARRANTIES, EITHER EXPRESS OR IMPLIED, INCLUDING BUT NOT LIMITED TO IMPLIED WARRANTIES OF MERCHANTABILITY AND FITNESS FOR A PARTICULAR PURPOSE, AND NONINFRINGEMENT.