



KB article reference no. Q101201

Version: 1.1

Keywords: KlasHopper 600 PCMCIA, OMNIxi

Dial with a KlasHopper 600 connected to an OMNIxi

The information in this article applies to:

- Windows XP
- KlasHopper 600 PCMCIA
- Dial-up Networking
- OMNIxi (Version: 2.5.3)

Table of Contents

1.0 Introduction.....	2
2.0 Cable Connections	2
3.0 Configure the OMNIxi.....	2
4.0 KlasHopper 600 PCMCIA Setup (Dial):	3
5.0 Dial-up Connection Configuration	4
6.0 Call Setup.....	9

Table of Figures

Figure 1. Sample Scenario using the KlasHopper 600 PCMCIA	2
Figure 2. KlasHopper 600 PCMCIA Setup Screen	3
Figure 3. Opening the Network Connections Window.....	4
Figure 4. Starting the Network Connection Wizard	4
Figure 5. Choosing the Network Connection Type	5
Figure 6. Choosing a Dial-Up Connection	5
Figure 7. Selecting the Network Device	6
Figure 8. Naming the Dial-Up Connection.....	6
Figure 9. Entering the Mandatory Dial-Up Number.....	7
Figure 10. Completing the New Connection Wizard.....	7
Figure 11. Editing the Dial-Up Connection Properties.....	8
Figure 12. Configuring the Dial-Up Connection for TCP/IP	8
Figure 13. Initiating the KlasHopper PPP Connection	9

1.0 Introduction

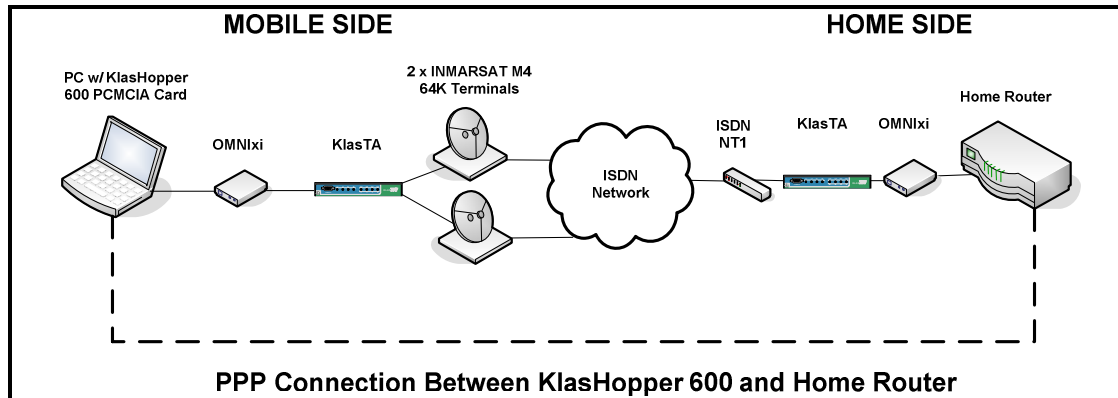

Figure 1. Sample Scenario using the KlasHopper 600 PCMCIA

This document describes how to configure the KlasHopper 600 PCMCIA to dial with an OMNIxi. Figure 1 represents a typical KlasHopper scenario in a deployed environment using satellite communications to connect back to a home network. In this example, the KlasHopper 600 on the Mobile Side is initiating a PPP connection using the OMNIxi for Type-1 Encryption. On the Home Side, the PPP connection can be terminated by either a router or another PC. On both sides, a KlasTA is used to access the Public ISDN network through the M4 INMARSAT terminals. Follow the directions in this document to configure the KlasHopper 600 network interface and complete the steps required to create and use a Dial-up Networking connection from a Windows XP PC.

2.0 Cable Connections

Prior to beginning, ensure the following cable connections have been properly secured:

1. KlasHopper 600 is connected to the female RS-530 connector on the OMNIxi.
2. Black OMNIxi cable is connected to the male RS-530 connector of the OMNIxi and the female RS-530 synchronous serial port on the KlasTA.
3. ISDN cables are connected to the RJ-45 ISDN Output Ports 1 and 2 from KlasTA and the ISDN ports on each M4 Terminal.

3.0 Configure the OMNIxi

The OMNIxi has a specific sequence of settings that allow it to encrypt data using the RS-530 serial data port. Follow the instructions from Application Note Q100009 in order to configure the OMNIxi so that it will work properly with the KlasHopper 600 and KlasTA.

4.0 KlasHopper 600 PCMCIA Setup (Dial):

To configure the KlasHopper 600 PCMCIA network interface, follow the instructions below.

1. From the Windows XP Desktop, go to Start – All Programs – KlasHopper 600 PCMCIA – KlasHopper 600 PCMCIA Configure.
2. In the KlasHopper 600 PCMCIA Setup Screen, select the 'Manual Dial' option from the 'Connection Mode' field.
3. Select 'RS-530/RS-449/X.21' option from the 'Interface' field.
4. No other settings are required. Click the 'OK' button to continue.

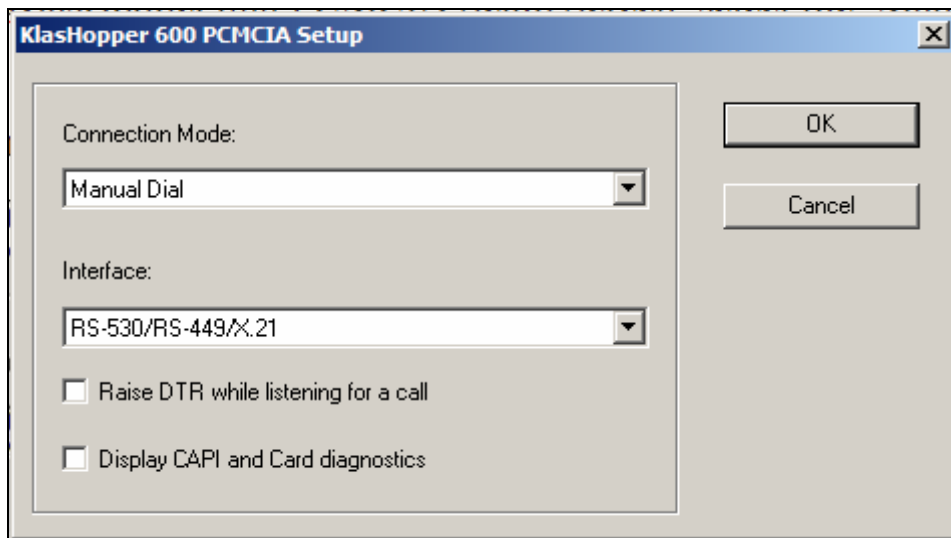

Figure 2. KlasHopper 600 PCMCIA Setup Screen

5.0 Dial-up Connection Configuration

To create a Dial-up Networking connection, follow the directions below.

1. From the Windows XP Desktop, go to Start – Network Connections, as shown in Figure 3 below.

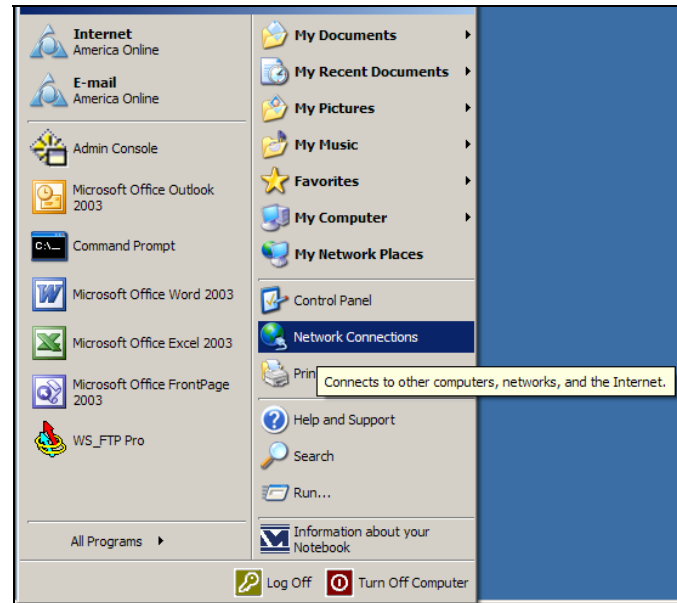

Figure 3. Opening the Network Connections Window

2. From the Network Tasks pane, double-click on the 'Create a new connection' icon to start the Network Connection Wizard. Click 'Next' to continue past the Welcome screen.



Figure 4. Starting the Network Connection Wizard

Dial with a KlasHopper 600 Connected to an OMNIxi

3. Select the 'Connect to the network at my workplace' option. Click 'Next' to continue.

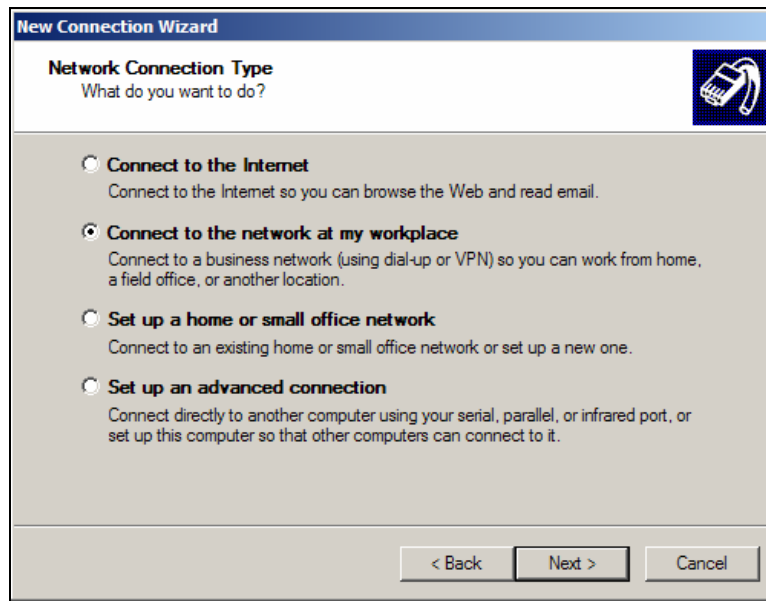

Figure 5. Choosing the Network Connection Type

4. Select the 'Dial-up Connection' option. Click 'Next' to continue.

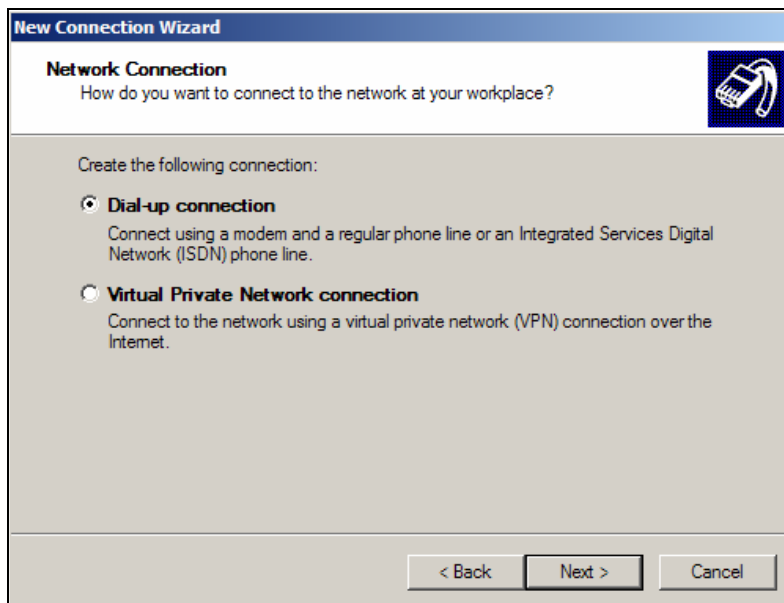

Figure 6. Choosing a Dial-Up Connection

Dial with a KlasHopper 600 Connected to an OMNIxi

5. Ensure that 'Modem – KlasHopper 600 PCMCIA PPP' is the only device that is selected. Click 'Next' to continue.

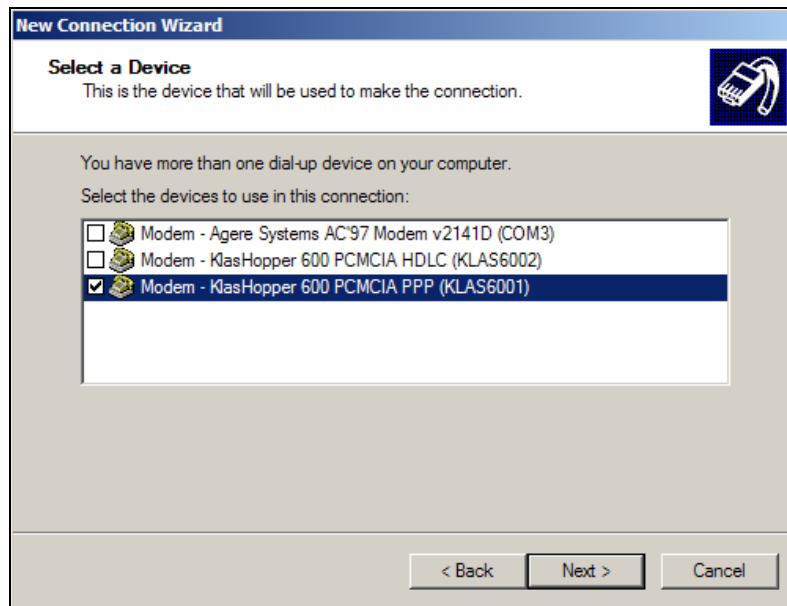

Figure 7. Selecting the Network Device

6. Enter a relevant name for this connection. Click 'Next' to continue.

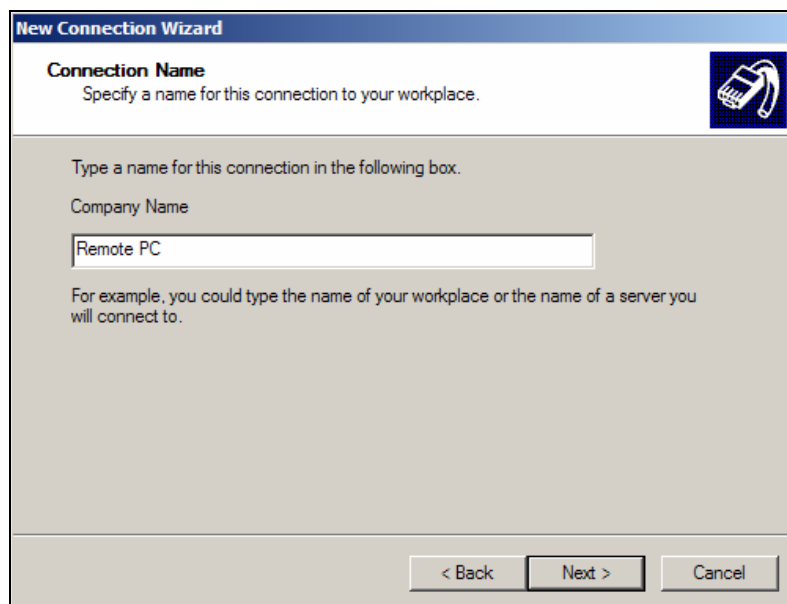

Figure 8. Naming the Dial-Up Connection

7. Enter a number in the 'Phone number' field (e.g. '123' as shown in Figure 7). Click 'Next' to continue. (*Note: Windows requires a number to be present; however, this number will not actually be used.*)

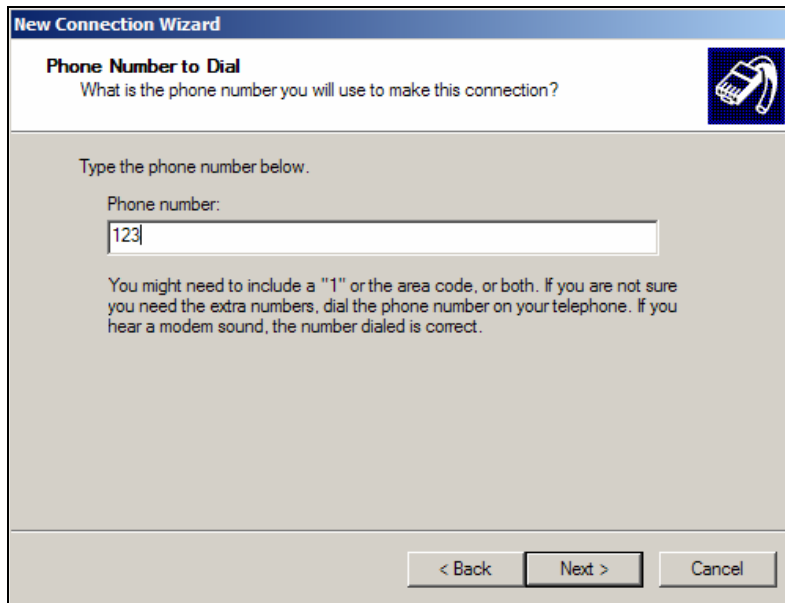

Figure 9. Entering the Mandatory Dial-Up Number

8. The New Connection Wizard is now complete. Click 'Finish' to create the connection and close the wizard.

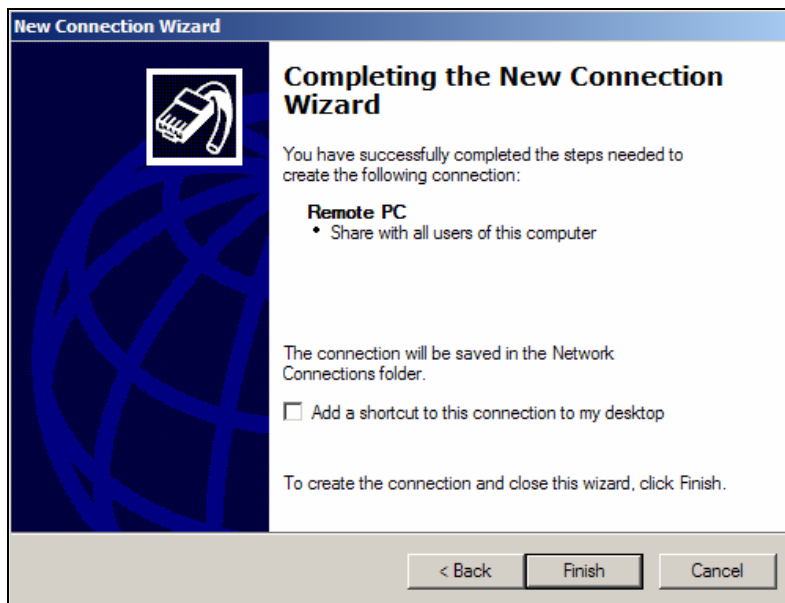

Figure 10. Completing the New Connection Wizard

9. Once the connection has been created, return to the Network Connections window, right-click on the Dial-Up Connection icon just created and select 'Properties'.

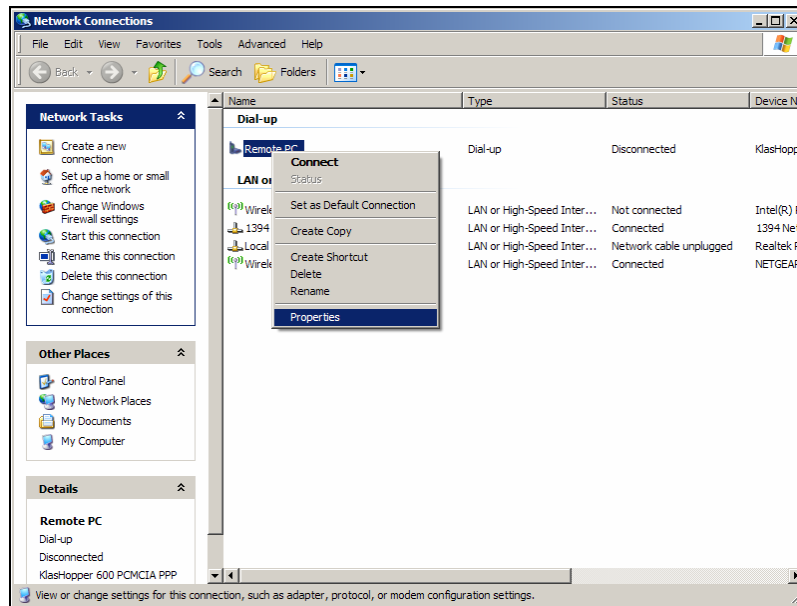

Figure 11. Editing the Dial-Up Connection Properties

10. Go to the 'Networking' tab. Ensure that 'Network Monitor Driver' and 'Internet Protocol (TCP/IP)' are the only options selected under 'This connection uses the following items'.

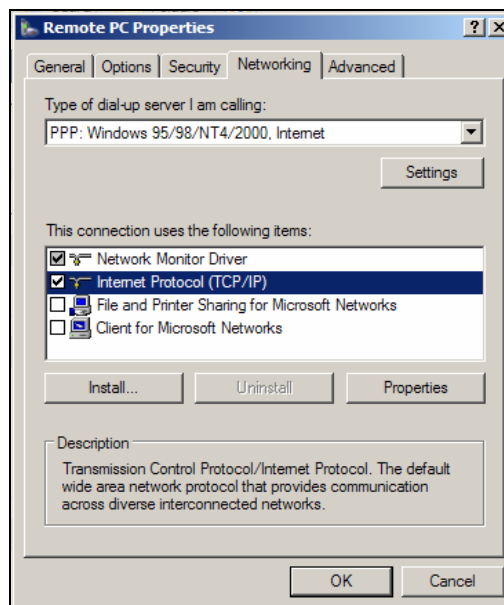

Figure 12. Configuring the Dial-Up Connection for TCP/IP

6.0 Call Setup

Once a connection has been manually made on the Black (secure) side of the connection, follow the instructions below to initiate the KlasHopper PPP connection:

1. Return to the Network Connections window.
2. Double-click on the connection that you have just created (*Remote PC*).
3. Enter the User name and Password for the PPP connection.
4. Click 'Dial' to initiate the call.



Figure 13. Initiating the KlasHopper PPP Connection

MORE INFORMATION

For more information about the KlasHopper 600 PCMCIA and other Klas products, visit the following Klas website:

<www.klasonline.com>

Copyright © 2006 Klas Ltd. All rights reserved. All company and brand names are trademarks or registered trademarks of their respective owners.

DISCLAIMER OF WARRANTY: THE DOCUMENT IS PROVIDED AS IS, WITHOUT WARRANTY OF ANY KIND. TO THE MAXIMUM EXTENT PERMITTED BY APPLICABLE LAW, WITH RESPECT TO THE DOCUMENT AND / OR ANY ASSOCIATED ON-LINE INFORMATION, KLAS DISCLAIMS ALL WARRANTIES, EITHER EXPRESS OR IMPLIED, INCLUDING BUT NOT LIMITED TO IMPLIED WARRANTIES OF MERCHANTABILITY AND FITNESS FOR A PARTICULAR PURPOSE, AND NONINFRINGEMENT.