



KB article reference no. Q101206

Version: 1.1

Keywords: KlasHopper 600 PCMCIA, STE

Answer with a KlasHopper 600 connected to a STE

The information in this article applies to:

- Windows XP
- KlasHopper 600 PCMCIA
- Dial-up Networking
- STE

Table of Contents

1.0 Introduction.....	2
2.0 Cable Connections	2
3.0 Configure the STE	2
4.0 KlasHopper 600 PCMCIA Setup (Answer):.....	3
5.0 Incoming Connection Configuration	4

Table of Figures

Figure 1. Sample Scenario using the KlasHopper 600 PCMCIA.....	Error! Bookmark not defined.
Figure 2. KlasHopper 600 PCMCIA Setup Screen	3
Figure 3. Opening the Network Connections Window.....	4
Figure 4. Starting the Network Connection Wizard	4
Figure 5. Choosing the Network Connection Type	5
Figure 6. Accepting an Incoming Connection	5
Figure 7. Selecting the Network Device	6
Figure 8. Configuring the Incoming VPN Options.....	6
Figure 9. Selecting the Allowed Users	7
Figure 10. Accepting the Default Networking Software	7
Figure 11. Completing the New Connection Wizard.....	8

1.0 Introduction

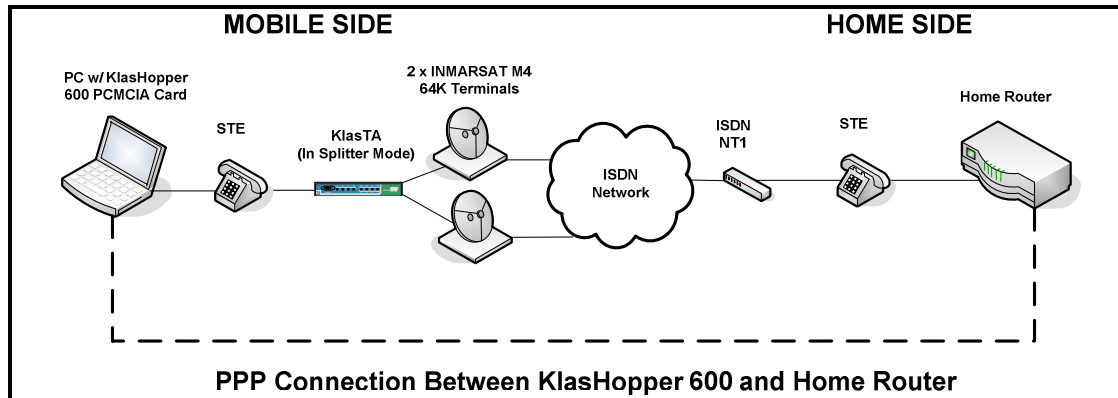

Figure 1. Sample Scenario using the KlasHopper 600 PCMCIA

This document describes how to configure the KlasHopper 600 PCMCIA to answer with a STE. Figure 1 represents a typical KlasHopper scenario in a deployed environment using satellite communications to connect back to a home network. In this example, the KlasHopper 600 on the Mobile Side is terminating a PPP connection using the STE for Type-1 Encryption. On the Home Side, the PPP connection can be initiated by either a router or another PC. On the Mobile side, a KlasTA is used to access the Public ISDN network through the M4 INMARSAT terminals. Follow the directions in this document to configure the KlasHopper 600 network interface and complete the steps required to create and use a Dial-up Networking connection from a Windows XP PC.

2.0 Cable Connections

Prior to beginning, ensure the following cable connections have been properly secured:

1. KlasHopper 600 cable (KHHS023) is connected to the female RS-530 connector on the STE.
2. ISDN cable is connected from the ISDN port on the STE to the RJ-45 Input Port on KlasTA.
3. ISDN cables are connected to the RJ-45 ISDN Output Ports 1 and 2 from KlasTA and the ISDN ports on each M4 Terminal.

3.0 Configure the STE

The STE has a specific sequence of settings that allow it to encrypt data using the RS-530 serial data port. Follow the instructions from Application Note Q100014 in order to configure the STE so that it will work properly with the KlasHopper 600 and KlasTA.

4.0 KlasHopper 600 PCMCIA Setup (Answer):

To configure the KlasHopper 600 PCMCIA network interface, follow the instructions below.

1. From the Windows XP Desktop, go to Start – All Programs – KlasHopper 600 PCMCIA – KlasHopper 600 PCMCIA Configure.
2. In the KlasHopper 600 PCMCIA Setup Screen, select the 'Hot Dial / Hot Answer' option from the 'Connection Mode' field.
3. Select 'RS-530A' option from the 'Interface' field.
4. Ensure the 'Raise DTR while listening for a call' option is selected.
5. No other settings are required. Click the 'OK' button to continue.

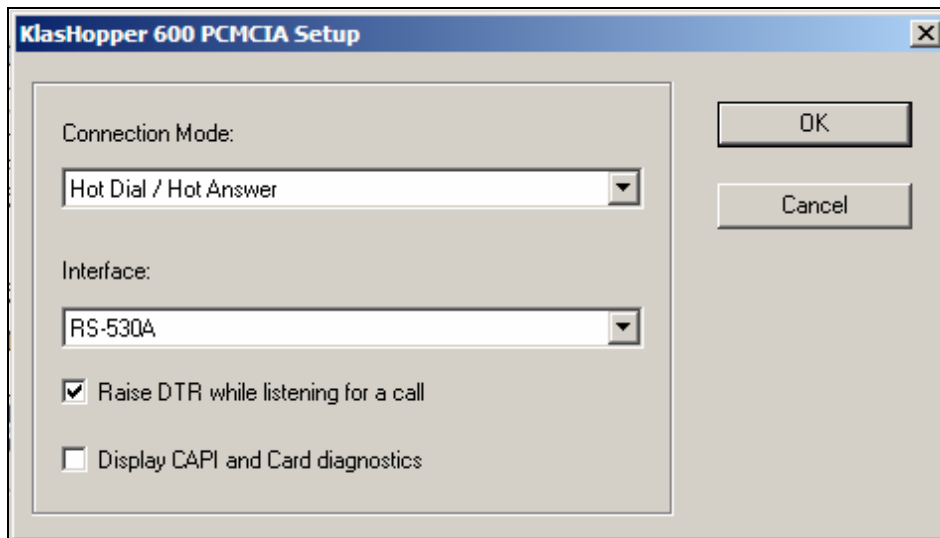

Figure 2. KlasHopper 600 PCMCIA Setup Screen

5.0 Incoming Connection Configuration

To create an Incoming Connection, follow the directions below.

1. From the Windows XP Desktop, go to Start – Network Connections, as shown in Figure 3 below.

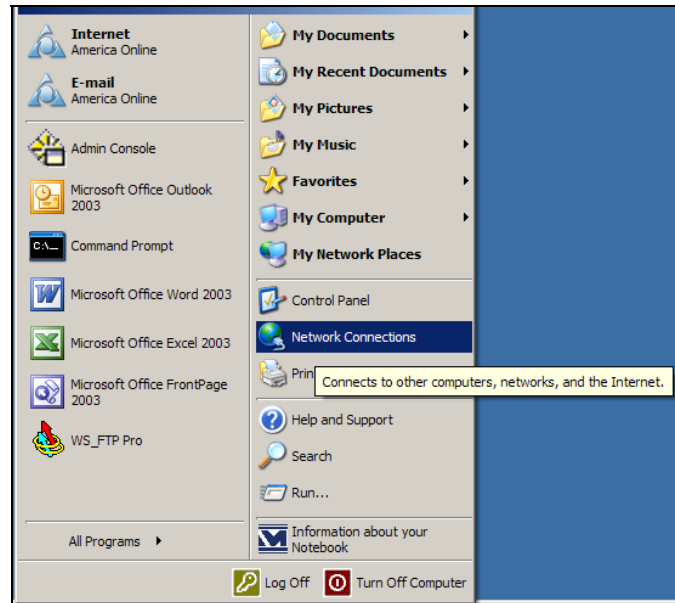

Figure 3. Opening the Network Connections Window

2. From the Network Tasks pane, double-click on the 'Create a new connection' icon to start the Network Connection Wizard. Click 'Next' to continue past the Welcome screen.



Figure 4. Starting the Network Connection Wizard

Answer with a KlasHopper 600 Connected to a STE

3. Select the 'Set up an advanced connection' option. Click 'Next' to continue.

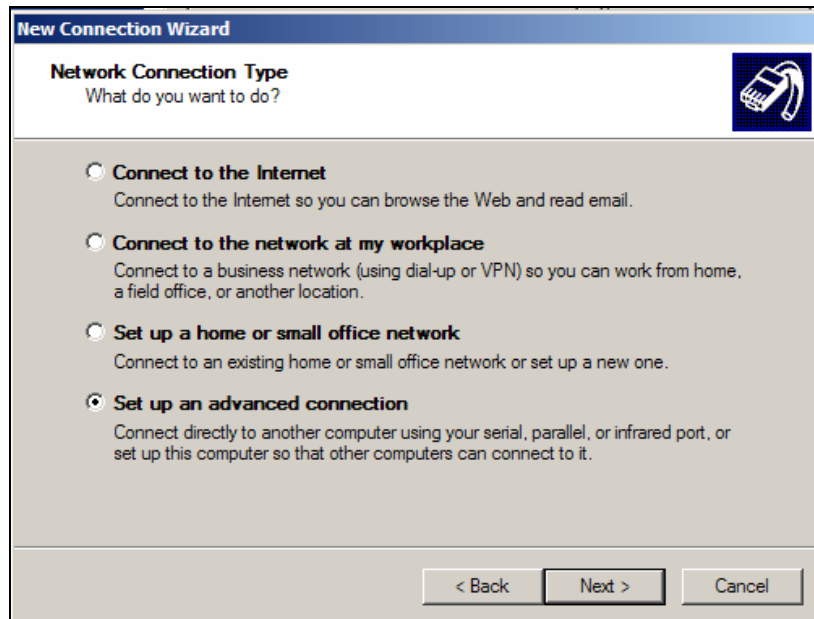

Figure 5. Choosing the Network Connection Type

4. Select the 'Accept incoming connections' option. Click 'Next' to continue.

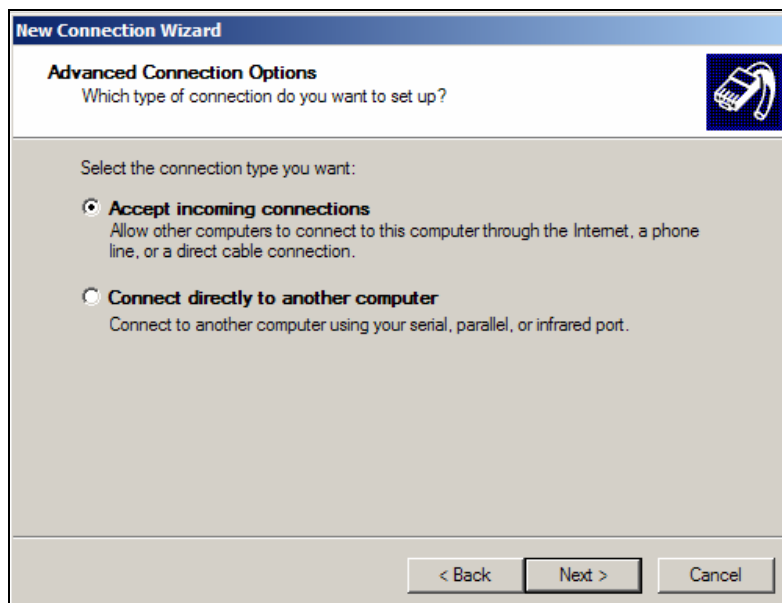

Figure 6. Accepting an Incoming Connection

5. Ensure that 'KlasHopper 600 PCMCIA PPP' is the only device that is selected. Click 'Next' to continue.

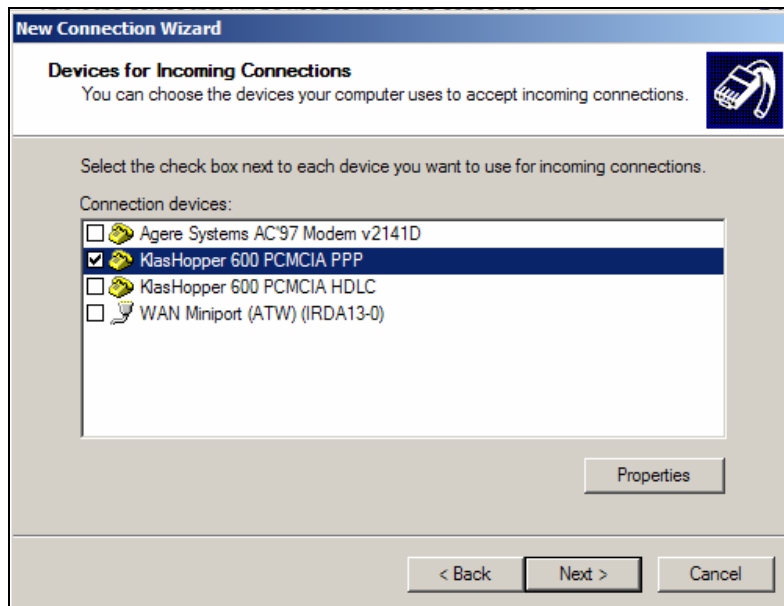

Figure 7. Selecting the Network Device

6. The wizard will now prompt you to choose whether you want to accept incoming VPN connections. Klas recommends checking the 'Do not allow virtual private connections' box to prevent VPN connections. Click 'Next' to continue.

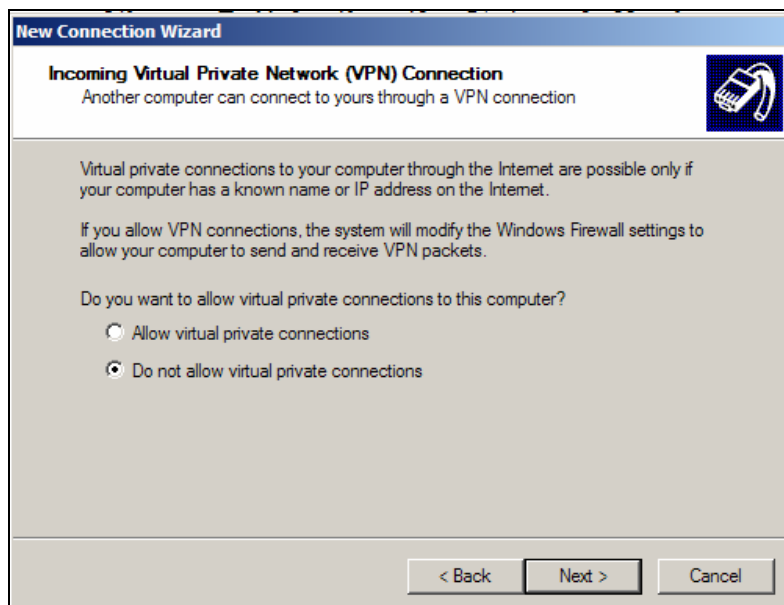

Figure 8. Configuring the Incoming VPN Options

7. Select which users are allowed to connect to your PC (Add users if required). Click 'Next' to continue.

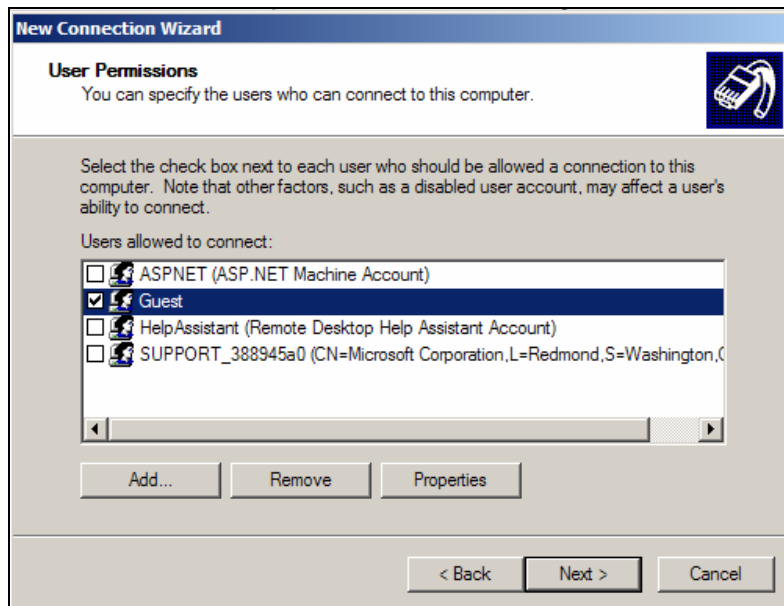

Figure 9. Selecting the Allowed Users

8. Accept the default Networking Software components selected. Click 'Next' to continue.

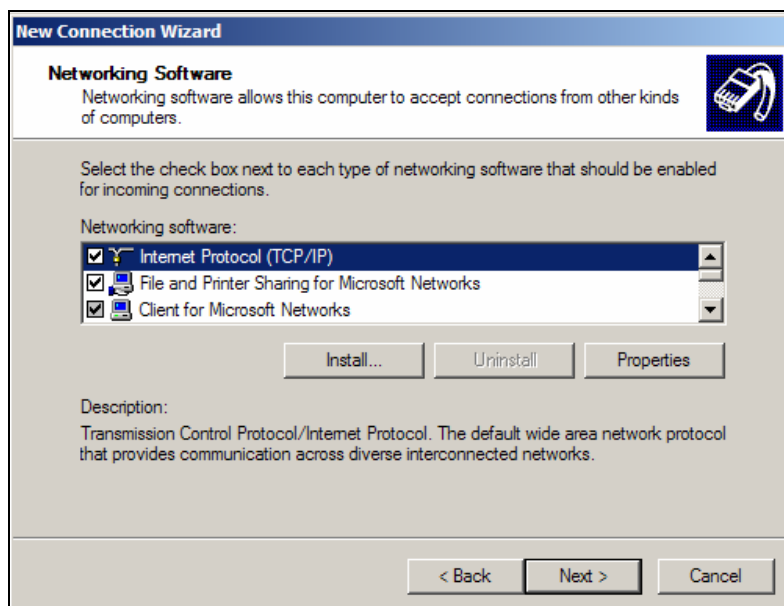

Figure 10. Accepting the Default Networking Software

9. The New Connection Wizard is now complete. Click 'Finish' to create the connection and close the wizard.



Figure 11. Completing the New Connection Wizard

The KlasHopper 600 PCMCIA is now configured to listen for and accept incoming calls.

MORE INFORMATION

For more information about the KlasHopper 600 PCMCIA and other Klas products, visit the following Klas website:

<www.klasonline.com>

Copyright © 2006 Klas Ltd. All rights reserved. All company and brand names are trademarks or registered trademarks of their respective owners.

DISCLAIMER OF WARRANTY: THE DOCUMENT IS PROVIDED AS IS, WITHOUT WARRANTY OF ANY KIND. TO THE MAXIMUM EXTENT PERMITTED BY APPLICABLE LAW, WITH RESPECT TO THE DOCUMENT AND / OR ANY ASSOCIATED ON-LINE INFORMATION, KLAS DISCLAIMS ALL WARRANTIES, EITHER EXPRESS OR IMPLIED, INCLUDING BUT NOT LIMITED TO IMPLIED WARRANTIES OF MERCHANTABILITY AND FITNESS FOR A PARTICULAR PURPOSE, AND NONINFRINGEMENT.