



Configuring a KlasTA to Answer with an OMNIxi using Bonding Mode 2

KB article reference no. Q103107

Version: 1.0

Keywords: KlasTA, OMNIxi, Answer, Bonding Mode 2

The information in this article applies to:

- o KlasTA
- o OMNIxi

Table of Contents

1.0 Introduction.....	2
2.0 Cable Connections	2
3.0 Configure the OMNIxi to work with KlasTA.....	3
4.0 Configuring KlasTA	3

Table of Figures

Figure 1. Sample Scenario using the OMNIxi for Type-1 Encryption.....	2
Figure 2. KlasTA Configuration Main Screen.....	3
Figure 3. KlasTA Configuration Profiles Screen.....	3
Figure 4. KlasTA Input Device Screen.....	4
Figure 5. KlasTA Network Type Screen	4
Figure 6. KlasTA Bonding Mode Screen	5
Figure 7. KlasTA Dial and Answer Screen	5
Figure 8. KlasTA Hunt Group Numbering Screen	6
Figure 9. KlasTA D-Channel Protocol Screen	6
Figure 10. KlasTA Extra Configuration Commands Screen	7
Figure 11. KlasTA Configuration Summary Screen.....	7
Figure 12. Downloading BM2 Firmware Version.....	8
Figure 13. KlasTA Configuration Progress Screen	8
Figure 14. KlasTA Profile Screen.....	9

1.0 Introduction

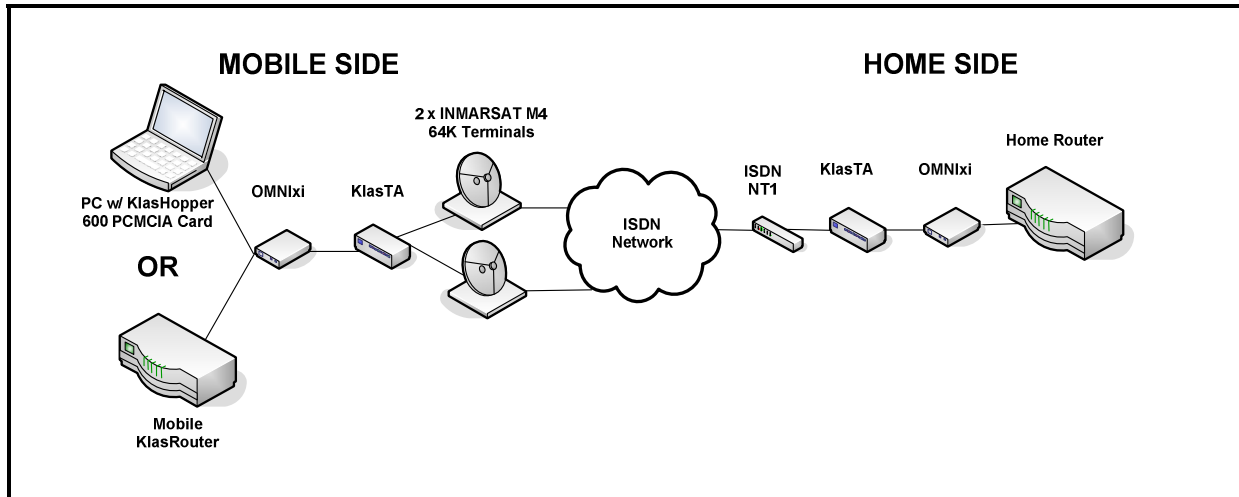

Figure 1. Sample Scenario using the OMNixi for Type-1 Encryption

This document describes how to configure a KlasTA connected to an OMNixi on the Home Side to answer a 128K ISDN call, as shown in Figure 1. When configured for answer mode, KlasTA is continually listening for incoming calls and will answer automatically.

In this example, KlasTA uses the Bonding Mode 2 protocol in order to multiplex the 128K data stream to the RS-530 synchronous serial port connected to the OMNixi. The OMNixi will unencrypt the data and send it to an RS-530 synchronous serial port on the Home Side router for further processing. Bonding Mode 2 can be used over satellite since it has a limited amount of error-recovery. However, Bonding Mode 2 is a relatively immature and seldom-used protocol. It has not been widely adopted which leads to incompatibility issues among vendors. Therefore, Bonding Mode 2 should be used with caution and only if the Klas AERO protocol is not an option.

Follow the directions in the sections below outlining the steps from the KlasTA configuration wizard.

2.0 Cable Connections

Prior to beginning, ensure the following cable connections have been properly secured:

1. Power cord is plugged in and KlasTA is on.
2. Control Port Cable is connected to the PC's serial port.
3. Control Port Cable is connected to the 'Control' port on the front of the KlasTA.
4. Black OMNixi cable is connected to the male RS-530 connector of the OMNixi and the female RS-530 synchronous serial port on the KlasTA.
5. ISDN cables are connected to the RJ-45 ISDN Output Ports 1 and 2 from KlasTA and the RJ-45 S/T Input Ports on an ISDN NT1 device.

**Configure a KlasTA to Answer with an OMNixi using
Bonding Mode 2**

3.0 Configure the OMNIxi to work with KlasTA

The OMNIxi has a specific sequence of settings that allow it to encrypt data using the RS-530 serial data port. Follow the instructions from Q100010 in order to configure the KIV-7 so that it will work properly with KlasTA.

4.0 Configuring KlasTA

Open the KlasTA configuration application on your PC. Follow the steps below to configure KlasTA.

1. Click on the 'Configure' button on the opening menu.

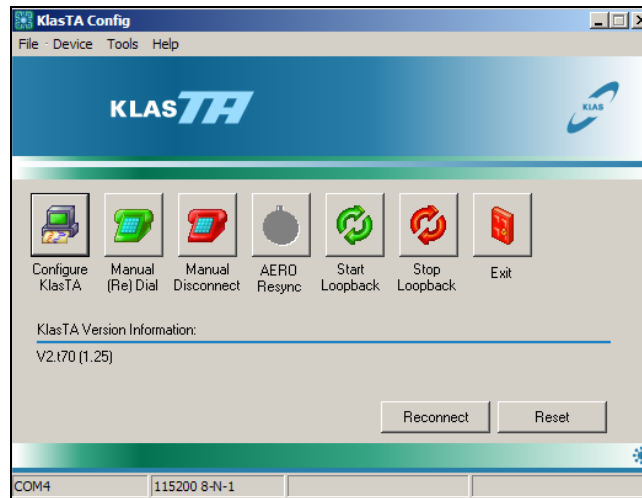

Figure 2. KlasTA Configuration Main Screen

2. Check the 'Configure KlasTA using step-by-step wizard' radio button. Click the 'Next' button to continue and move on to the next configuration screen.

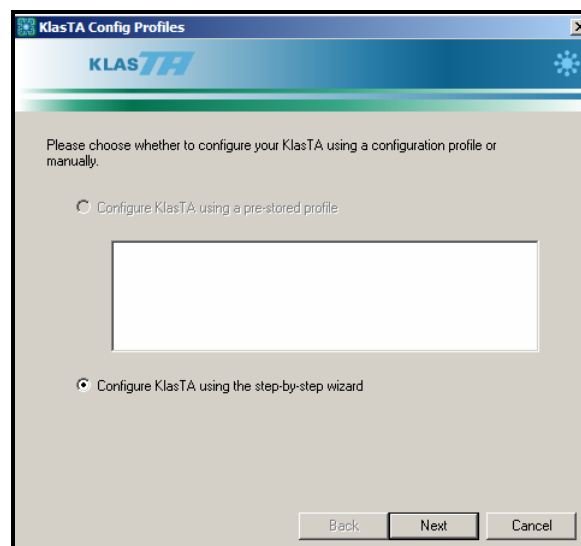

Figure 3. KlasTA Configuration Profiles Screen

Configure a KlasTA to Answer with an OMNIxi using Bonding Mode 2

3. Check the 'Encryption Device' radio button and select OMNI as the Encryption Device from the pull-down menu. **(Note: This parameter must be identical for the KlasTAs on both sides of the call.)**

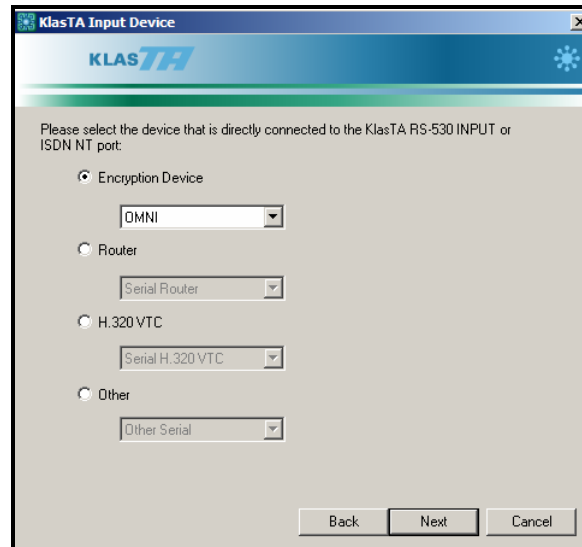

Figure 4. KlasTA Input Device Screen

4. Select the 'Terrestrial' radio button indicating you will be answering the call from an ISDN landline BRI connection.

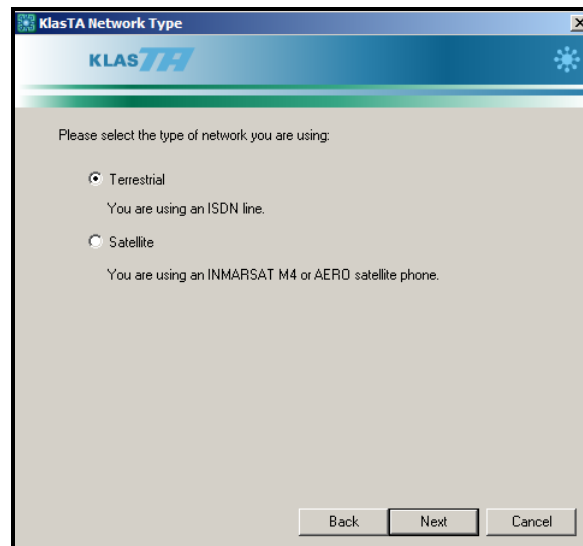

Figure 5. KlasTA Network Type Screen

**Configure a KlasTA to Answer with an OMNIxi using
Bonding Mode 2**

5. Select the 'Bonding Mode 2' radio button indicating that both KlasTAs will be using the Bonding Mode 2 protocol.

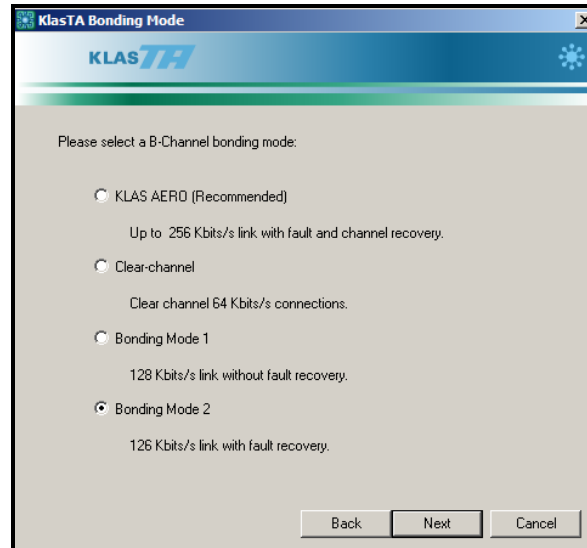

Figure 6. KlasTA Bonding Mode Screen

6. Select the 'Answer only' radio button indicating that KlasTA will continually monitor the line for incoming ISDN calls.

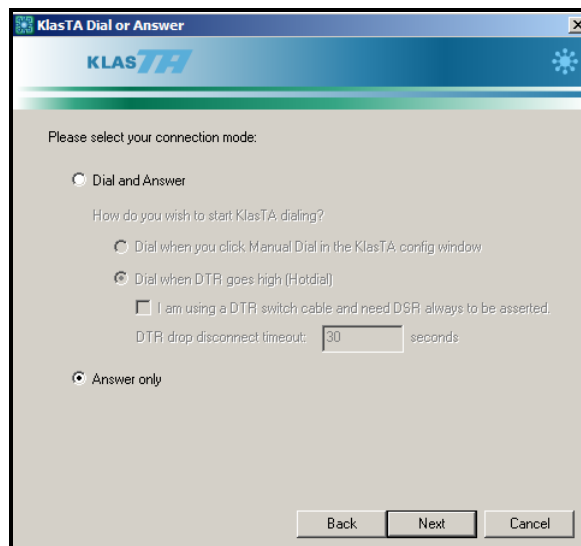

Figure 7. KlasTA Dial and Answer Screen

**Configure a KlasTA to Answer with an OMNIxi using
Bonding Mode 2**

7. The KlasTA Answer configuration screen gives users the option to enable Hunt Group numbering by clicking the 'My ISDN system uses Hunt Group numbering' box. Once the KlasTA receives the first number from a dialing TA, the Hunt Group numbering feature will send the remaining numbers needed back to the dialing TA. Additionally, you can also set the time KlasTA will wait to fall back to 64K if no additional numbers are available. The default is 50 seconds.

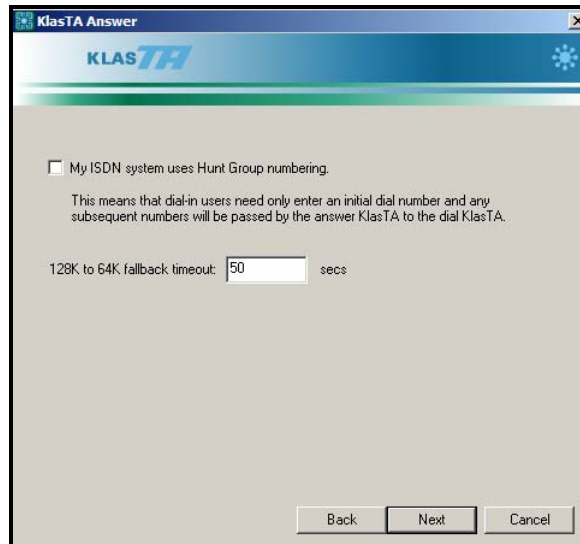

Figure 8. KlasTA Hunt Group Numbering Screen

8. Select the radio button next to the ISDN Switch-Type or D-Channel Protocol you are using, as shown in Figure 9 with the NI1/NI2 protocol. If NI1/NI2 or AT&T 5ESS is chosen, you must also enter the Service Profile Identifiers (SPIDs) associated with the ISDN lines connected to KlasTA. SPIDs are assigned by your local Telecom Provider and are unique for each 64K channel.

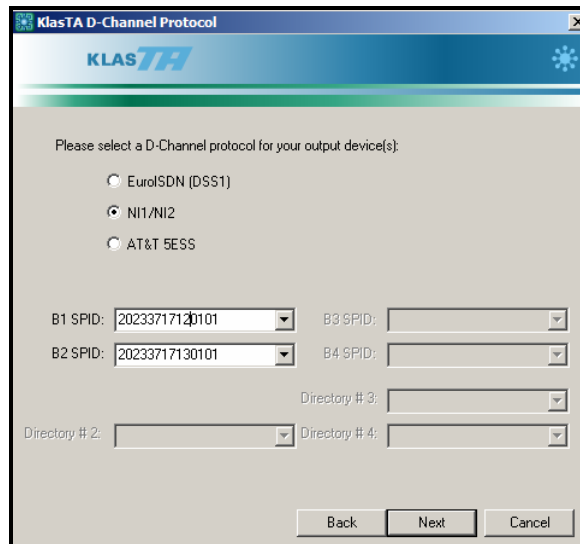

Figure 9. KlasTA D-Channel Protocol Screen

Configure a KlasTA to Answer with an OMNIxi using Bonding Mode 2

9. The Extra Config Commands screen allows you to enter manual commands that enable seldom used features. No extra configuration commands are needed for this setup.

Figure 10. KlasTA Extra Configuration Commands Screen

10. Review the configuration options to ensure they are correct and then click on the 'Configure' button to initiate the configuration sequence on the KlasTA.

Figure 11. KlasTA Configuration Summary Screen

Configure a KlasTA to Answer with an OMNIxi using Bonding Mode 2

11. If required, KlasTA may initially erase and reflash the firmware needed to support Bonding Mode 2, as shown in Figure 12. Once the firmware change is complete, the configuration settings will be loaded into KlasTA, as shown in Figure 13. Click on the 'OK' button once the configuration sequence has successfully completed.

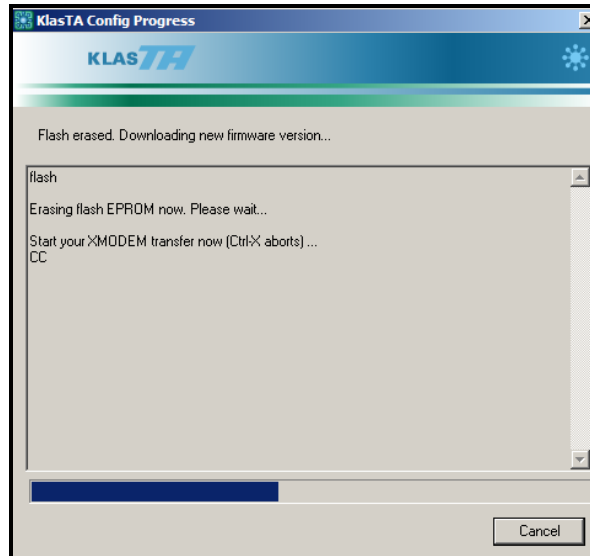

Figure 12. Downloading BM2 Firmware Version

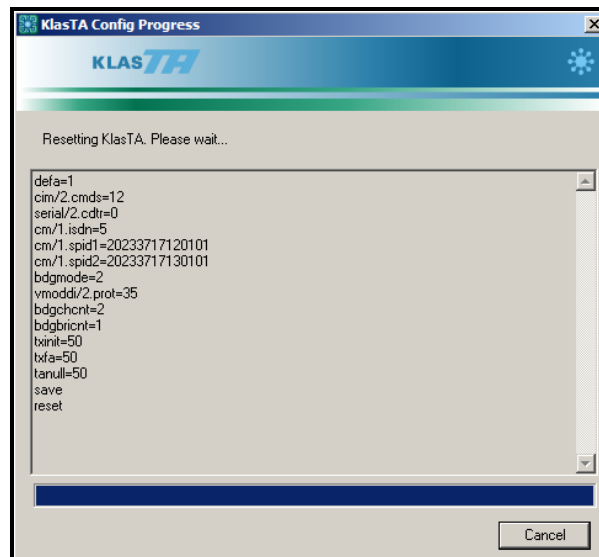

Figure 13. KlasTA Configuration Progress Screen

Configure a KlasTA to Answer with an OMNIxi using Bonding Mode 2

12. If desired, click the 'Yes' radio button to save this configuration. Click on the 'Finish' button to go back to the Main Menu.

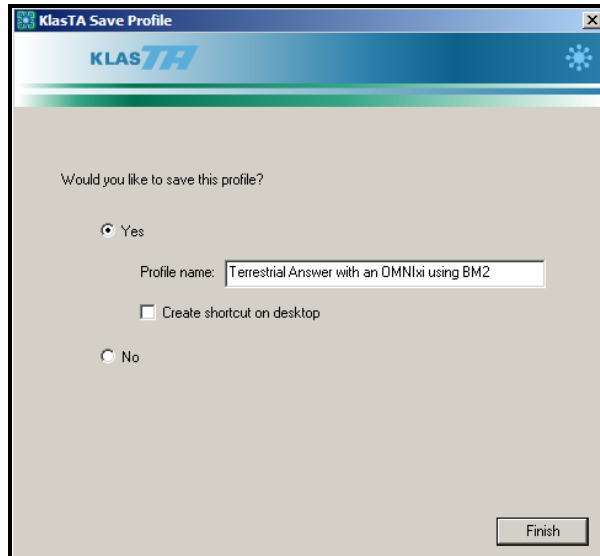

Figure 14. KlasTA Profile Screen

MORE INFORMATION

For more information about KlasTA and other Klas products, visit the following Klas website:

<www.klasonline.com>

Copyright © 2005 Klas Ltd. All rights reserved. All company and brand names are trademarks or registered trademarks of their respective owners.

DISCLAIMER OF WARRANTY: THE DOCUMENT IS PROVIDED AS IS, WITHOUT WARRANTY OF ANY KIND. TO THE MAXIMUM EXTENT PERMITTED BY APPLICABLE LAW, WITH RESPECT TO THE DOCUMENT AND / OR ANY ASSOCIATED ON-LINE INFORMATION, KLAS DISCLAIMS ALL WARRANTIES, EITHER EXPRESS OR IMPLIED, INCLUDED BUT NOT LIMITED TO IMPLIED WARRANTIES OF MERCHANTABILITY AND FITNESS FOR A PARTICULAR PURPOSE, AND NONINFRINGEMENT.

**Configure a KlasTA to Answer with an OMNIxi using
Bonding Mode 2**