



# Configuring KlasTA to Manual Dial with a KIV-7 using Clear Channel

*KB article reference no. Q103120*

*Version: 1.0*

*Keywords: KlasTA, KIV-7, Manual Dial, Clear Channel*

The information in this article applies to:

- KlasTA
- KIV-7

## Table of Contents

1.0 Introduction.....	2
2.0 Cable Connections .....	2
3.0 Configure the KIV-7 to work with KlasTA .....	2
4.0 Configuring KlasTA .....	3

## Table of Figures

Figure 1. Sample Scenario using the KIV-7 for Type-1 Encryption .....	2
Figure 2. KlasTA Configuration Main Screen.....	3
Figure 3. KlasTA Configuration Profiles Screen.....	3
Figure 4. KlasTA Input Device Screen.....	4
Figure 5. KlasTA Network Type Screen .....	4
Figure 6. KlasTA Bonding Mode Screen .....	5
Figure 7. KlasTA Dial and Answer Screen .....	5
Figure 8. KlasTA Dial Parameters Screen.....	6
Figure 9. KlasTA Extra Configuration Commands Screen .....	6
Figure 10. KlasTA Configuration Summary Screen.....	7
Figure 11. Downloading Clear Channel Firmware Version.....	7
Figure 12. KlasTA Configuration Progress Screen .....	8
Figure 13. KlasTA Profile Screen.....	8

## 1.0 Introduction

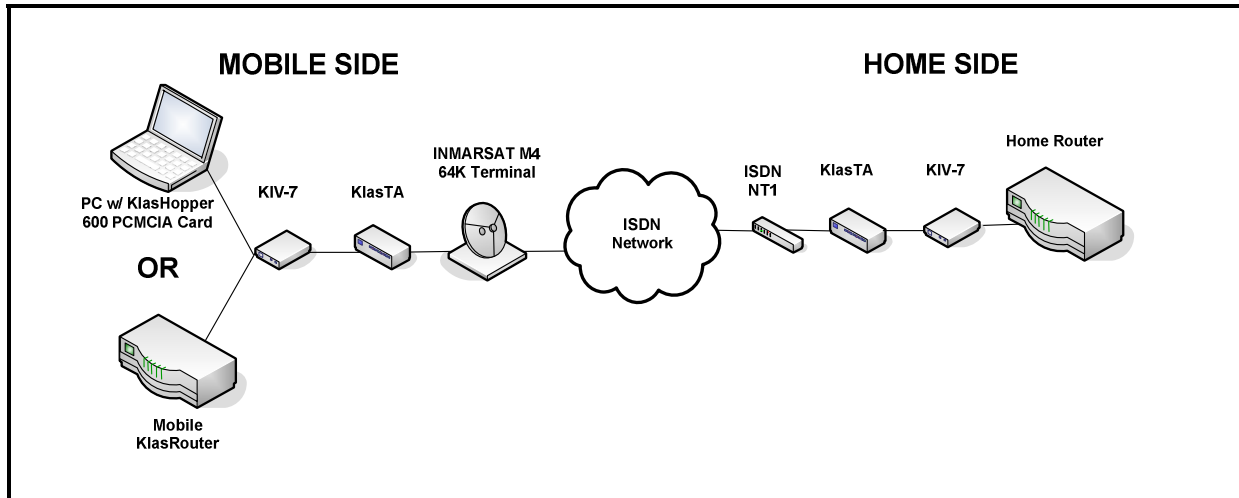

**Figure 1. Sample Scenario using the KIV-7 for Type-1 Encryption**

This document describes how to configure a KlasTA connected to a KIV-7 in order to manually dial a 64K connection using a single 64K INMARSAT satellite terminal. In this example, KlasTA uses the Clear Channel protocol in order to encapsulate the data stream from the RS-530 synchronous serial port into an individual 64K channel. This channel will be sent through the ISDN Output port on the KlasTA connected to the INMARSAT terminal. Follow the directions in the sections below outlining the steps from the KlasTA configuration wizard.

## 2.0 Cable Connections

Prior to beginning, ensure the following cable connections have been properly secured:

1. Power cord is plugged in and KlasTA is on.
2. Control Port Cable is connected to the PC's serial port.
3. Control Port Cable is connected to the 'Control' port on the front of the KlasTA.
4. Black KIV-7 cable is connected to the male RS-530 connector of the KIV-7 and the female RS-530 synchronous serial port on the KlasTA.
5. ISDN cables are connected to the RJ-45 ISDN Output Port 1 from KlasTA and the ISDN S/T port on the NT1 device.

## 3.0 Configure the KIV-7 to work with KlasTA

The KIV-7 has a specific sequence of settings that allow it to encrypt data using the RS-530 serial data port. Follow the instructions from Application Note Q100001 in order to configure the KIV-7 so that it will work properly with KlasTA.

**Configuring KlasTA to Manual Dial  
with a KIV-7 using Clear Channel**

## 4.0 Configuring KlasTA

Open the KlasTA configuration application on your PC. Follow the steps below to configure KlasTA.

1. Click on the 'Configure' button on the opening menu.



**Figure 2. KlasTA Configuration Main Screen**

2. Check the 'Configure KlasTA using step-by-step wizard' radio button. Click the 'Next' button to continue and move on to the next configuration screen.

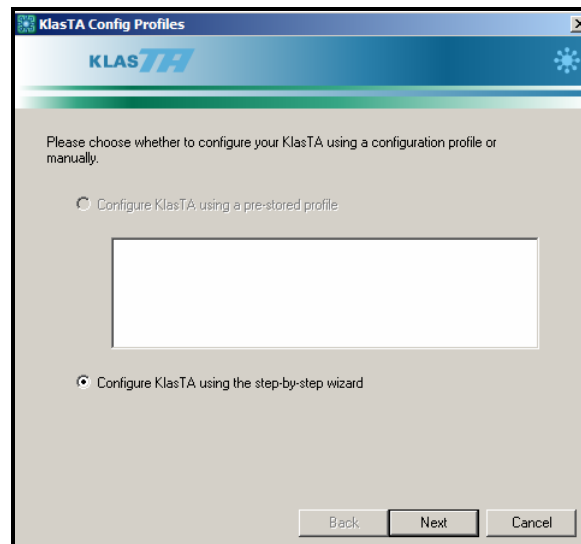

**Figure 3. KlasTA Configuration Profiles Screen**

### Configuring KlasTA to Manual Dial with a KIV-7 using Clear Channel

3. Check the 'Encryption Device' radio button and select KIV-7 as the Encryption Device from the pull-down menu. **(Note: This parameter must be identical for the KlasTAs on both sides of the call.)**

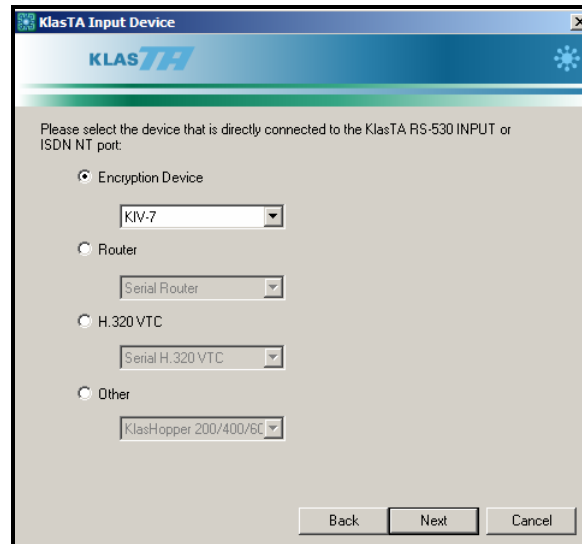

The screenshot shows a window titled "KlasTA Input Device" with the KLAS TA logo. The text reads: "Please select the device that is directly connected to the KlasTA RS-530 INPUT or ISDN NT port:". There are four radio button options, each with a corresponding pull-down menu:

- Encryption Device: KIV-7
- Router: Serial Router
- H.320 VTC: Serial H.320 VTC
- Other: KlasHopper 200/400/600

At the bottom right, there are three buttons: "Back", "Next", and "Cancel".

**Figure 4. KlasTA Input Device Screen**

4. Select the 'Satellite' radio button indicating you will be dialing from a satellite terminal.

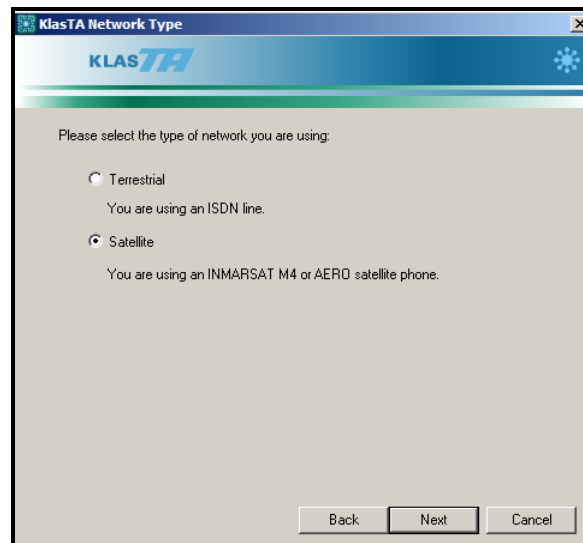

The screenshot shows a window titled "KlasTA Network Type" with the KLAS TA logo. The text reads: "Please select the type of network you are using:". There are two radio button options:

- Terrestrial: You are using an ISDN line.
- Satellite: You are using an INMARSAT M4 or AERO satellite phone.

At the bottom right, there are three buttons: "Back", "Next", and "Cancel".

**Figure 5. KlasTA Network Type Screen**

**Configuring KlasTA to Manual Dial  
with a KIV-7 using Clear Channel**

5. Select the 'Clear Channel' radio button indicating that both KlasTAs will be using the Clear Channel protocol.

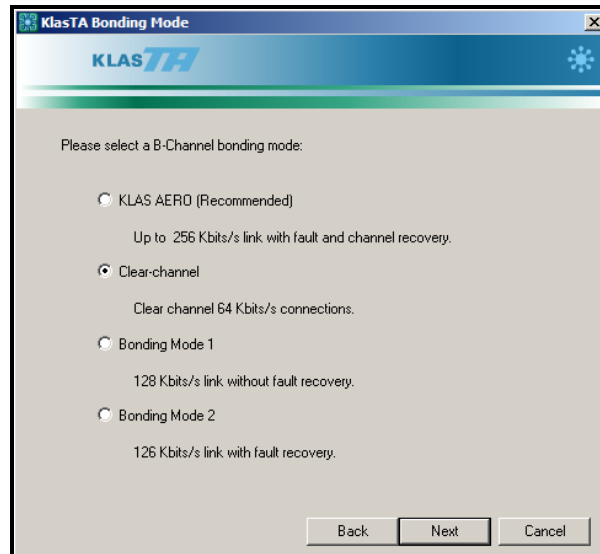

**Figure 6. KlasTA Bonding Mode Screen**

6. Select the 'Dial and Answer' radio button to enable KlasTA to initiate the dialing sequence. Also, check the 'Dial when you click Manual Dial in the KlasTA config window' radio button. This option specifies that KlasTA will only dial when you push the 'Manual Dial' button on the KlasTA Configuration Wizard Main Screen.

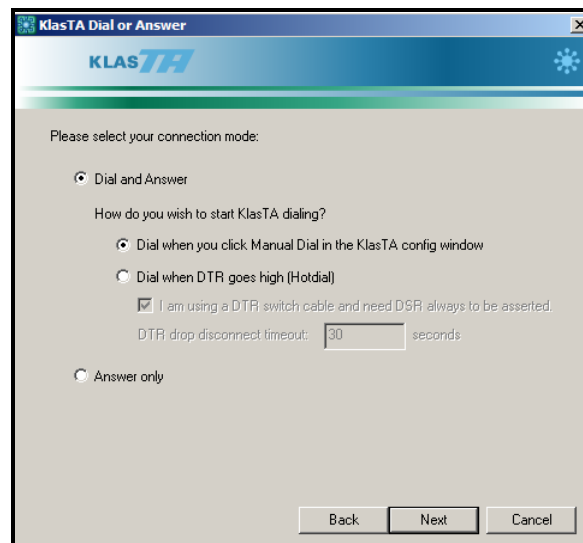

**Figure 7. KlasTA Dial and Answer Screen**

## Configuring KlasTA to Manual Dial with a KIV-7 using Clear Channel

- Input the dial string of the opposite KlasTA you would like to call. Since this is a 64K call, there is only one 64K B-channel. Ensure you type in '#' after the last digit in the dial string indicating to the KlasTA that the last number has been dialed.

**Figure 8. KlasTA Dial Parameters Screen**

- The Extra Config Commands screen allows you to enter manual commands that enable seldom used features. No extra configuration commands are needed for this setup.

**Figure 9. KlasTA Extra Configuration Commands Screen**

## Configuring KlasTA to Manual Dial with a KIV-7 using Clear Channel

9. Review the configuration options to ensure they are correct and then click on the 'Configure' button to initiate the configuration sequence on the KlasTA. Depending on the existing stored settings, you may be alerted that this configuration requires a firmware change. Click on the 'OK' button to continue the configuration sequence.

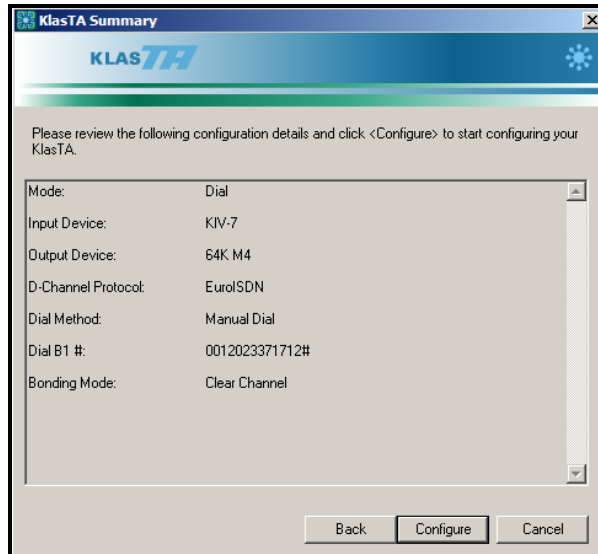

**Figure 10. KlasTA Configuration Summary Screen**

10. If required, KlasTA may initially erase and reflash the firmware needed to support Clear Channel, as shown in Figure 11. Once the firmware change is complete, the configuration settings will be loaded into KlasTA, as shown in Figure 12. Click on the 'OK' button once the configuration sequence has successfully completed.

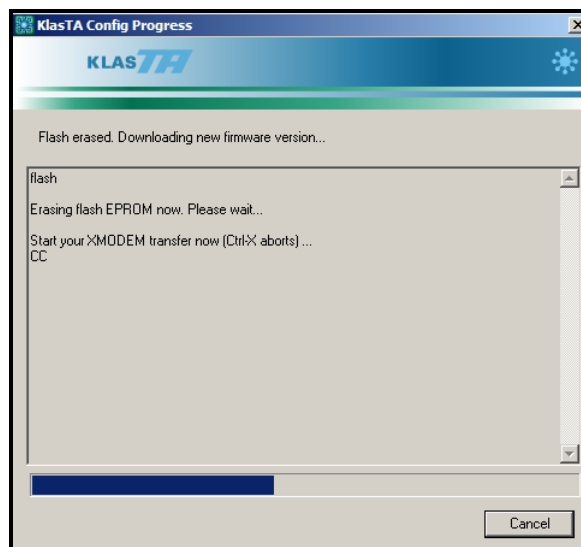

**Figure 11. Downloading Clear Channel Firmware Version**

## Configuring KlasTA to Manual Dial with a KIV-7 using Clear Channel

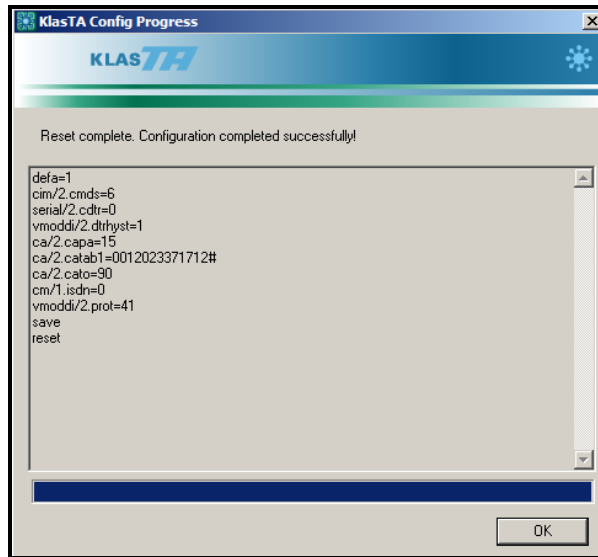

**Figure 12. KlasTA Configuration Progress Screen**

12. If desired, click the 'Yes' radio button to save this configuration. Click on the 'Finish' button to go back to the Main Menu.

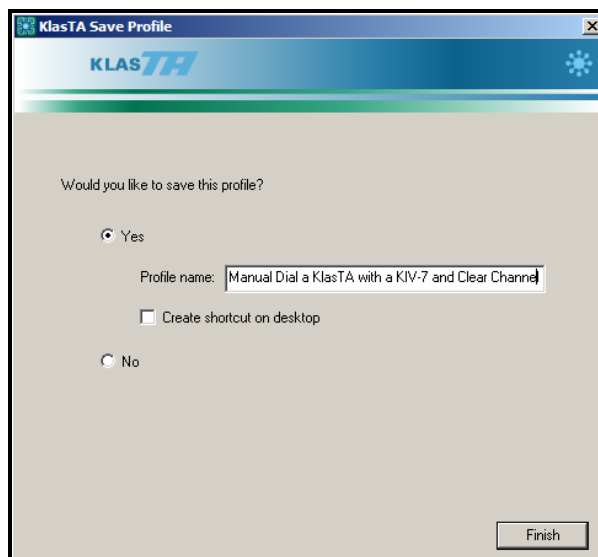

**Figure 13. KlasTA Profile Screen**

13. In the Main Menu, once you are ready to initiate the call, click on the 'Manual (Re) Dial' button with the green phone. This will begin the dialing sequence.

## Configuring KlasTA to Manual Dial with a KIV-7 using Clear Channel

## **MORE INFORMATION**

For more information about KlasTA and other Klas products, visit the following Klas website:

*<www.klasonline.com>*

Copyright © 2005 Klas Ltd. All rights reserved. All company and brand names are trademarks or registered trademarks of their respective owners.

**DISCLAIMER OF WARRANTY: THE DOCUMENT IS PROVIDED AS IS, WITHOUT WARRANTY OF ANY KIND. TO THE MAXIMUM EXTENT PERMITTED BY APPLICABLE LAW, WITH RESPECT TO THE DOCUMENT AND / OR ANY ASSOCIATED ON-LINE INFORMATION, KLAS DISCLAIMS ALL WARRANTIES, EITHER EXPRESS OR IMPLIED, INCLUDED BUT NOT LIMITED TO IMPLIED WARRANTIES OF MERCHANTABILITY AND FITNESS FOR A PARTICULAR PURPOSE, AND NONINFRINGEMENT.**